

Rozměry v mm
Maße in mm
Dimensions in mm

HEAT 3g L 88.50.01
STANDARD
270kg

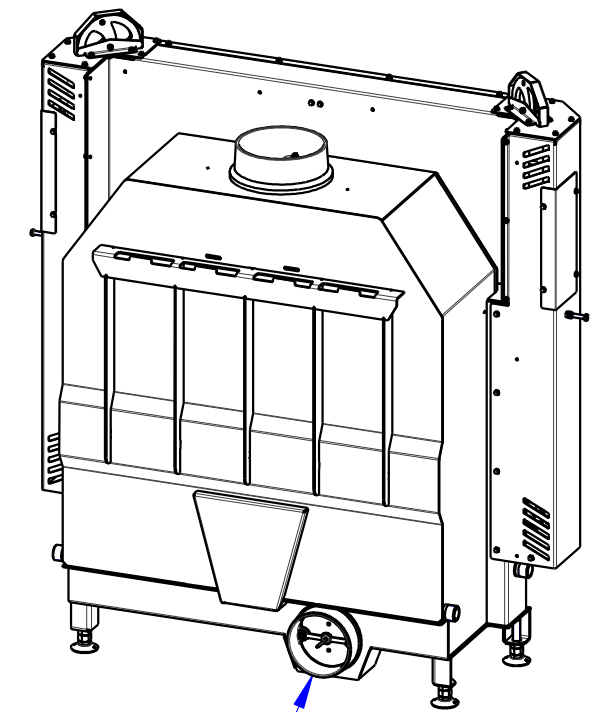
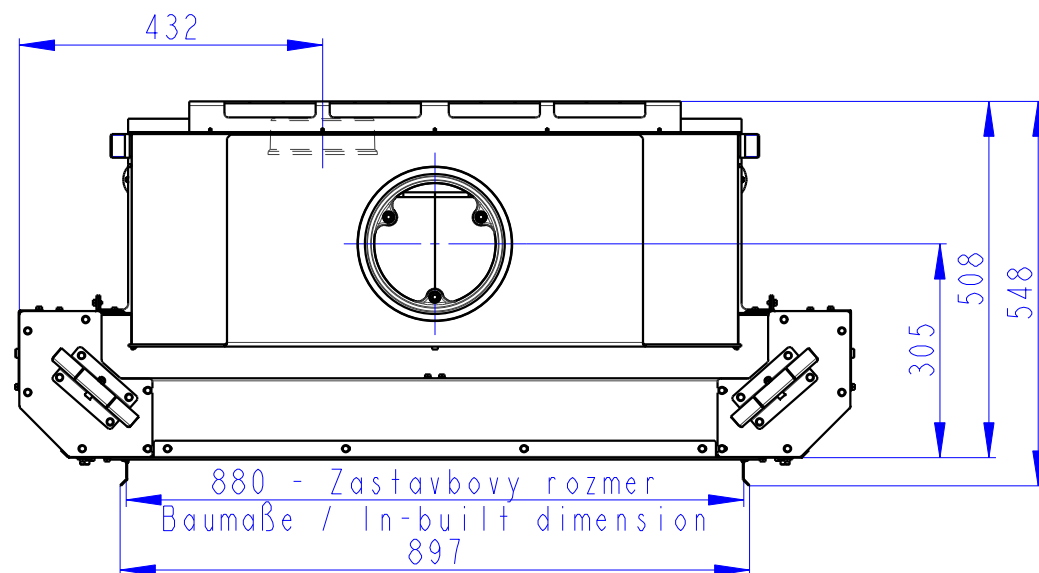
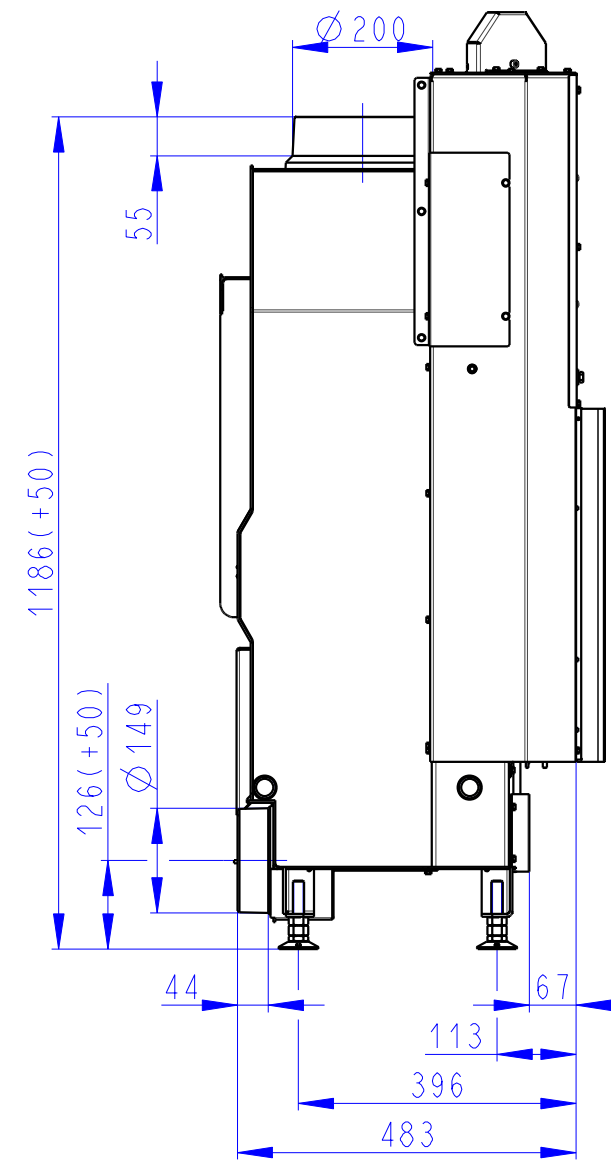
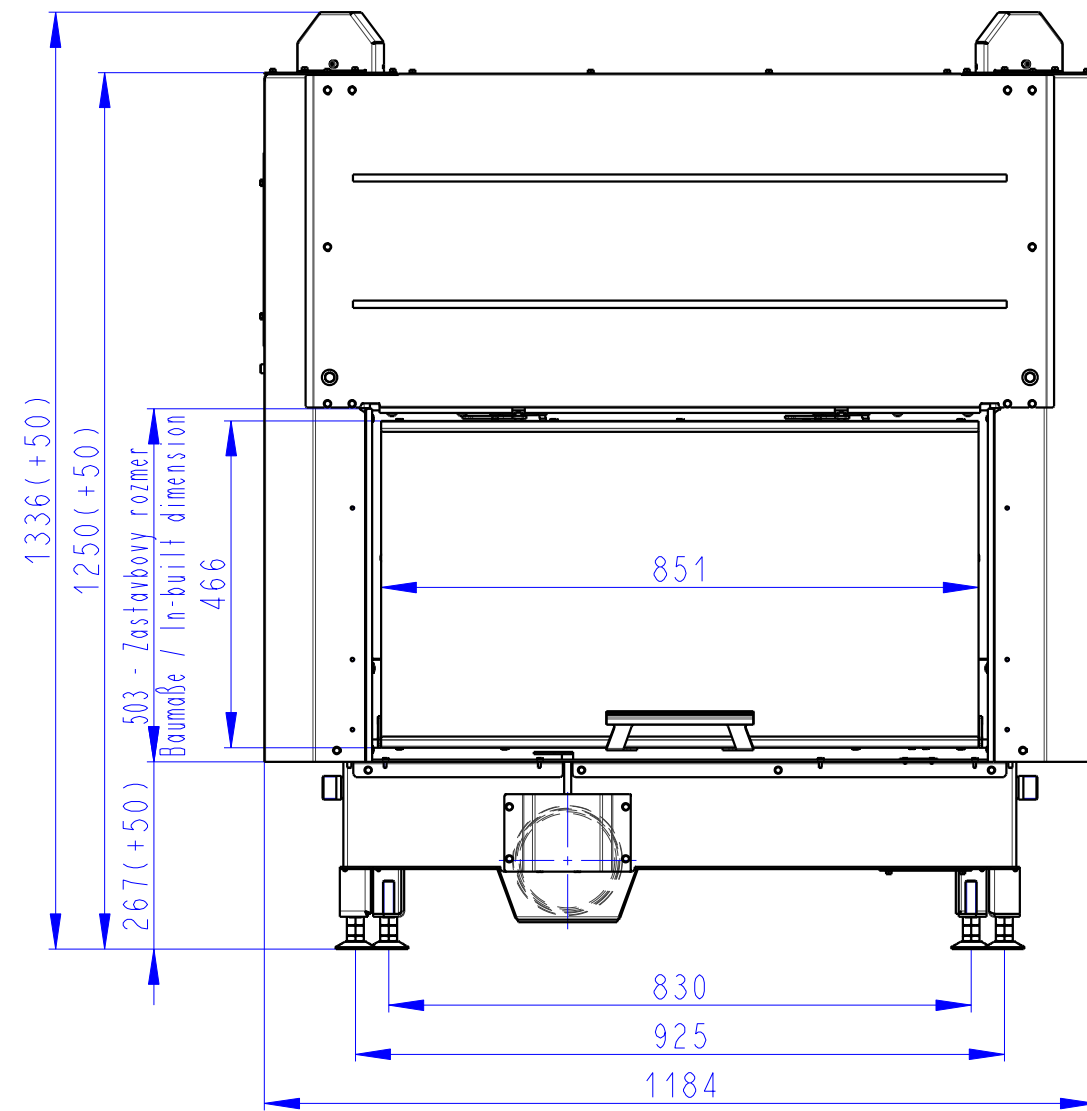

Centralni privod vzduchu
Central air inlet
Zentralluftzufuhr

Litinový odvod kouře
Cast iron spigot
Der gusseiserne Rauchabgang

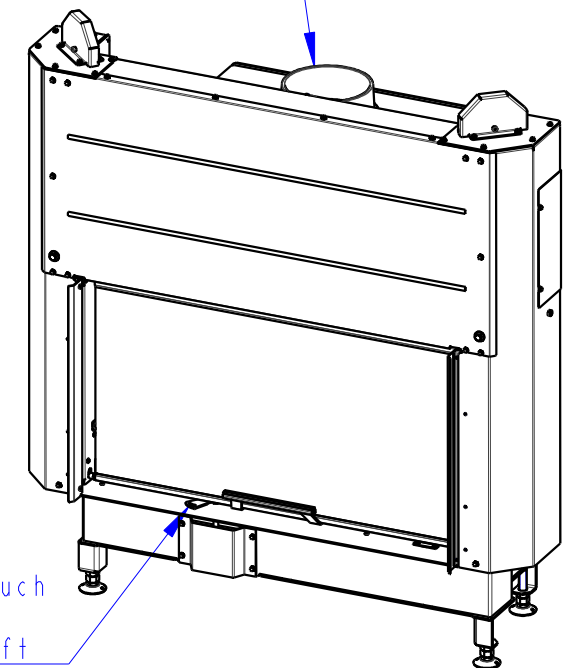

Primarni a sekundarni vzduch
Primary and secondary air
Primärluft und Sekundärluft