

Primární / Sekundární vzduch
Primärluft / Sekundärluft
Primary / Secondary air

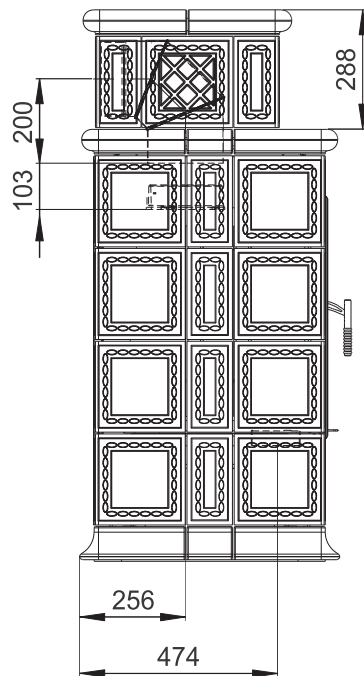

Centrální přívod vzduchu
Zentralluftzufuhr
Central air inlet

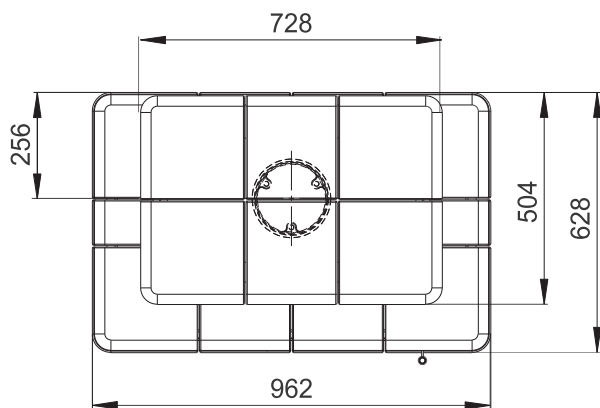
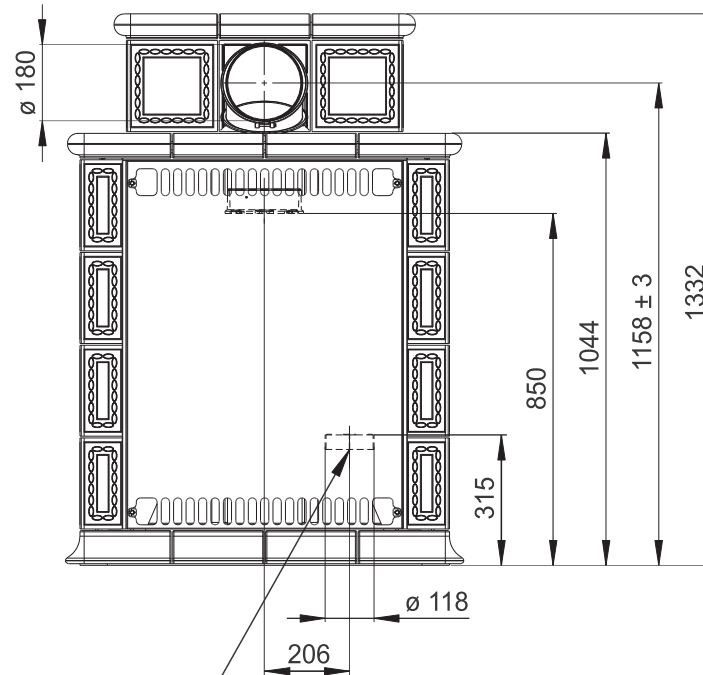

Rozměry v mm
Maße in mm
Dimensions in mm

| | | | |
|--|--------------------|---|----------------------|
| Kachlová kamna Kachelöfen Tiled Stoves | Typ Type Typ | BARACCA 7 | |
| Hmotnost Gewicht Weight | 325 kg | Rozměry topeniště (výška x šířka x hloubka) Maße Feuerraum (höhe x breite x tiefe) Combustion Chamber Dimensions (height x width x depth) | 330 x 520 x 300 (mm) |
| | | Hein & spol. - keramické závody, spol. s r. o. Odry - Tošovice | |