

Rozměry v mm
 Maße in mm
 Dimensions in mm

Heat 2g 70.44.01

168 kg

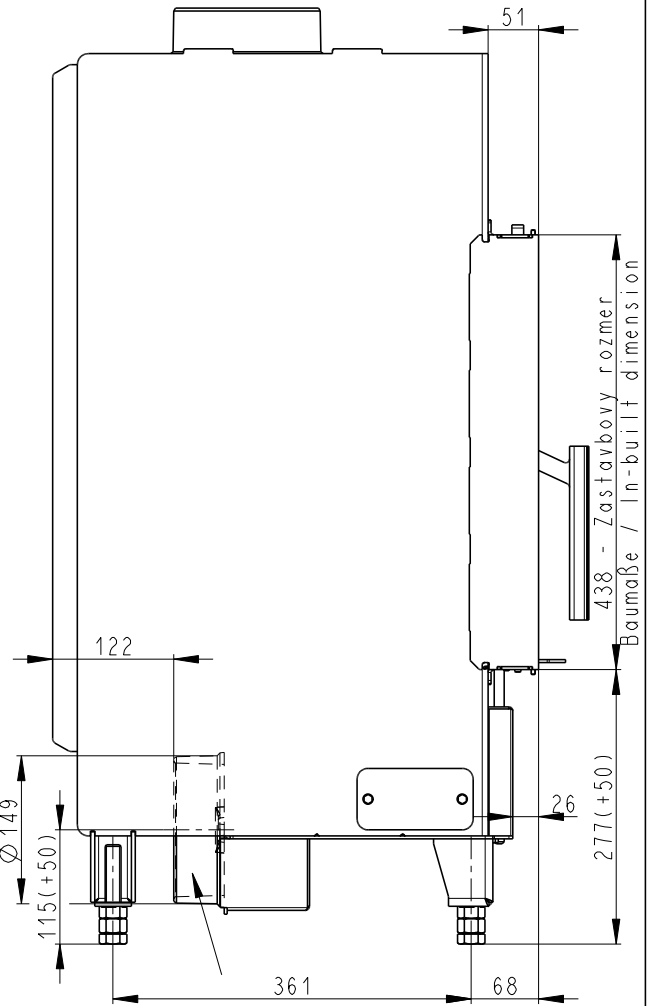
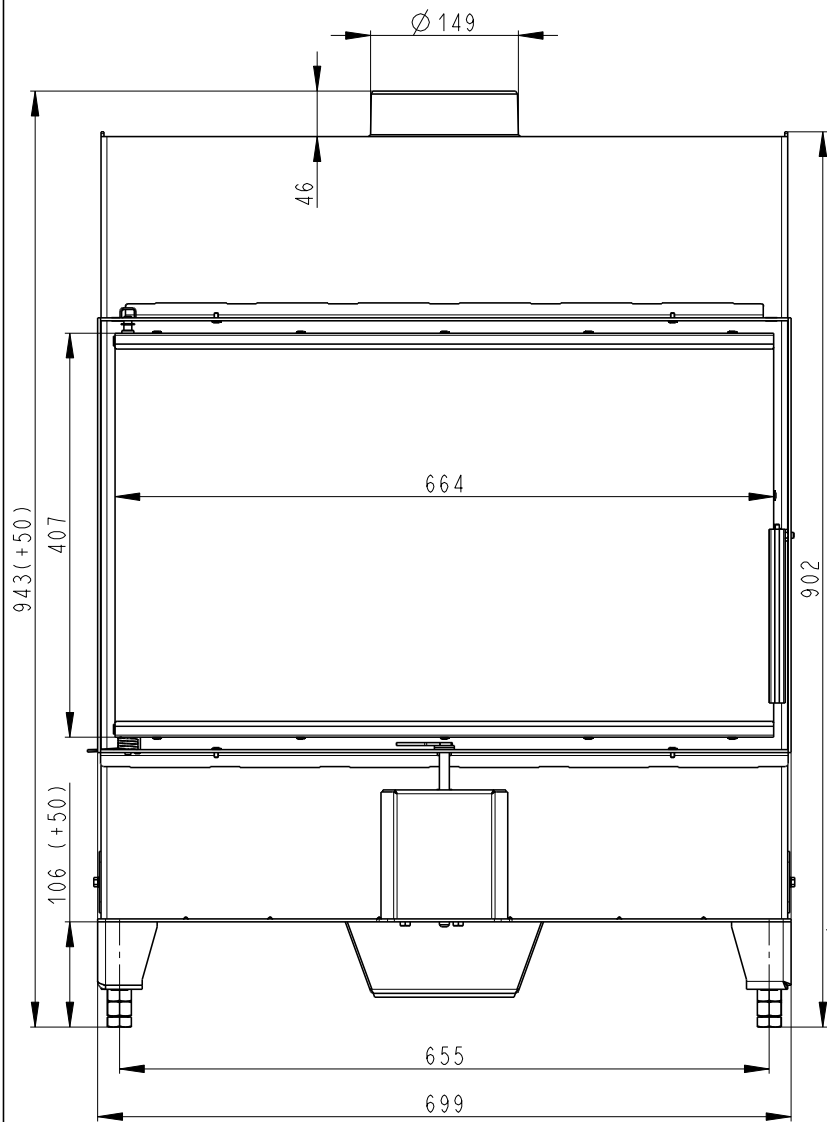

Litínový odvod kouře
 Cast iron spigot
 Der gusseiserne Rauchabgang

Centralni privod vzduchu
 Central air inlet
 Zentralluftzufuhr

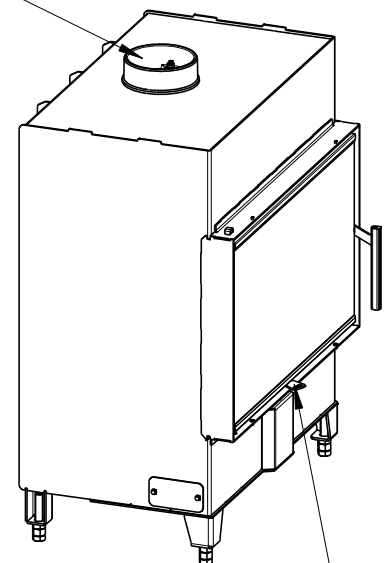
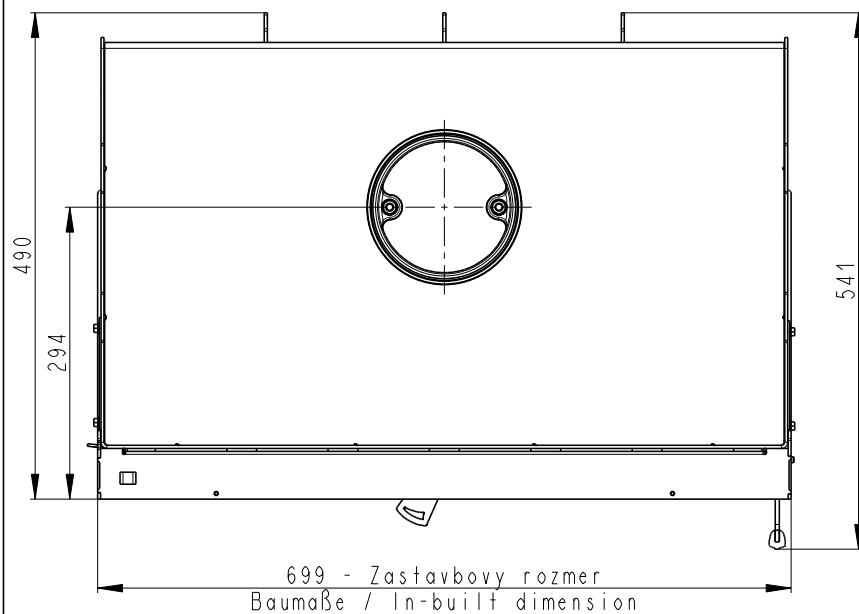

Primarni a sekundarni vzduch
 Primärluft und Sekundärluft
 Primary and secondary air